

**WASHDOWN 6M**

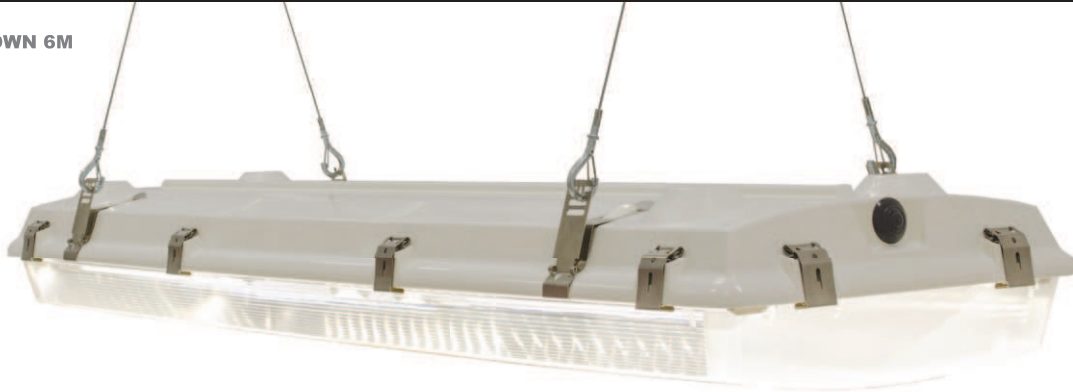

**ABOUT THE LUSIO WASHDOWN SERIES**

The Lusio Commercial and Industrial Washdown Series features LED high bay fixtures for use in demanding environments that require watertight seals including food/beverage processing, cold storage, warehouses, garden centers, and industrial facilities. Engineered with the latest energy efficient LED technology, each Lusio Washdown model includes an injection molded fiberglass body with a sturdy lens to withstand environments where extreme dust and moisture are factors.

**WASHDOWN 6M FIXTURE DESCRIPTION**

The six module (6M) washdown fixture features a water-tight housing (nominal 4 x 1 ft or 122 x 30.5 cms). The fixture is available in two LED color temperatures (nominal 5200K and 3985K) and with three lens choices including clear options for maximum light output and frosted options for enhanced glare control.

**WASHDOWN 6M • LIGHT OUTPUT**

	WATTAGE <sup>1</sup>	LUMENS <sup>1</sup>	EFFICACY <sup>1</sup>	CRI <sup>2</sup>
<b>CLEAR, POLYCARBONATE LENS (CLPC)</b>				
COOL WHITE (5200K +/- 475K) <sup>3</sup>	180	16,300	90.6	70
NEUTRAL WHITE (3985K +/- 275K) <sup>3</sup>	180	16,200	90.0	70
<b>CLEAR, ACRYLIC LENS (CLAC)</b>				
COOL WHITE (5200K +/- 475K) <sup>3</sup>	180	16,900	93.9	70
NEUTRAL WHITE (3985K +/- 275K) <sup>3</sup>	180	16,900	93.9	70
<b>FROSTED, ACRYLIC LENS (FRAC)</b>				
COOL WHITE (5200K +/- 475K) <sup>3</sup>	180	16,600	92.2	70
NEUTRAL WHITE (3985K +/- 275K) <sup>3</sup>	180	16,500	91.7	70

<sup>1</sup>Typical <sup>2</sup>Typical CRI. Contact factory if your application has specific requirements of 70 CRI minimum or higher.  
<sup>3</sup>Consult factory for other CCT offerings. Lead times may be longer.

**WASHDOWN 6M • DIMENSIONS: INS (CMS)<sup>1</sup>**

LENGTH	WIDTH	DEPTH <sup>2</sup>	WEIGHT
52-3/8 (133)	14-5/8 (37.1)	CLPC, CLAC, FRAC 6 (15.2)	23 LBS (10.4 KGS)

<sup>1</sup>Dimensions listed are for the fixture only. See dimensional drawings for measurements with mounting hardware.  
<sup>2</sup>CLPC: Clear, polycarbonate lens CLAC: Clear, acrylic lens FRAC: Frosted, acrylic lens

**NOTES**

**WASHDOWN 6M • FEATURES**

**POWER**

- **POWER INPUT:** 100-277V, 347-480V (50/60 Hz). Consult factory for lead time on 347-480V models.
- **DRIVE CURRENT:** 700mA
- **DIMMING:** Optional factory installed dimmable power supply (10-100% dimming) that interfaces to standard third party 0-10v dimmers.

	TYPICAL POWER FACTOR	TYPICAL TOTAL HARMONIC DISTORTION
120V	0.996	5.8%
277V	0.931	13.2%
347V	0.960	16.2%
480V	0.911	18.3%

**RELIABILITY/LUMEN MAINTENANCE**

- Reported 93% lumen maintenance (L93) at 60,000 hours

**FIXTURE**

- **ENVIRONMENT:** Wet, high pressure washdown, interior or exterior applications.
- **HOUSING:**
  - UL 5VA fiberglass housing (will not melt or burn).
  - Weatherability (f1) rated. Suitable for outdoor use with respect to exposure to ultraviolet light, water exposure and immersion in accordance with UL 746.
- **LENSES:** Lenses are high efficiency, UV stabilized acrylic or polycarbonate. **Consult acrylic/polycarbonate compatibility chart for guidance in selecting the appropriate lensing material for your application.**
- **MOUNTING CLIPS:** Stainless steel. Cables supplied by others or see Accessories for Lusio cable kits.
- **WARRANTY:** Limited product only 5-year warranty. See complete warranty coverage and exclusions details online at [www.LusioLighting.com](http://www.LusioLighting.com).
- **REPLACEABLE LED LIGHT MODULES:** Allows field replacement of individual light modules. See Installation Instructions.
- **AMBIENT OPERATING TEMPERATURE:**

SURFACE	-4° to 86°F (-20° to 30°C)	SUSPENSION	-4° to 95°F (-20° to 35°C)
---------	-------------------------------	------------	-------------------------------

**LISTINGS AND CERTIFICATIONS**

- ETL
- NSF (non-food zone and splash zone)
- NEMA 4X
- IP66
- RoHS compliant
- FCC Class A
- Made in the USA (contact factory)
- Lighting Facts (U.S. Department of Energy) certified



**WASHDOWN 6M SAMPLE ORDERING NUMBER<sup>1</sup>**

LW-LUSIO-WD-6M-CW-CLAC-120-DIM-C15

**PHOTO**



LW-LUSIO-WD-6M															
PART NUMBER	LED COLOR TEMPERATURE	LENS OPTIC AND MATERIAL <sup>3</sup>	VOLTAGE												
	<p><b>CW</b> Cool white<sup>2</sup> 5200K +/- 475K</p> <p><b>NW</b> Neutral white<sup>2</sup> 3985K +/- 275K</p>	<p><b>CLPC</b> Clear, polycarbonate</p> <p><b>CLAC</b> Clear, acrylic</p> <p><b>FRAC</b> Frosted, acrylic</p>	<table border="1"> <tr> <td><b>120</b></td> <td><b>277</b></td> </tr> <tr> <td>120V</td> <td>277V</td> </tr> <tr> <td><b>208</b></td> <td><b>347</b></td> </tr> <tr> <td>208V</td> <td>347V<sup>4</sup></td> </tr> <tr> <td><b>240</b></td> <td><b>480</b></td> </tr> <tr> <td>240V</td> <td>480V<sup>4</sup></td> </tr> </table>	<b>120</b>	<b>277</b>	120V	277V	<b>208</b>	<b>347</b>	208V	347V <sup>4</sup>	<b>240</b>	<b>480</b>	240V	480V <sup>4</sup>
<b>120</b>	<b>277</b>														
120V	277V														
<b>208</b>	<b>347</b>														
208V	347V <sup>4</sup>														
<b>240</b>	<b>480</b>														
240V	480V <sup>4</sup>														

DIMMING	CORD/PLUG	MOUNTING
<p><b>DIM</b> Dimming For no dimming, leave part number field blank</p>	<p><b>C6</b> 6 ft (1.8 m), 600v SOW cord, no plug<sup>5</sup></p> <p><b>C15</b> 15 ft (4.6 m), 600v SOW cord, no plug<sup>5</sup> For no cord/plug, leave part number field blank</p>	<p><b>RMT</b> Rigid mounting bracket for surface or dual pendant mounting<sup>6</sup> For cable ready fixtures, leave part number field blank<sup>7</sup></p>

**NOTES**

- Information on Lusio accessories is available on a separate specification sheet.
- Consult factory for other CCT/CRI offerings. Lead times may be longer.
- Consult acrylic/polycarbonate compatibility chart for guidance in selecting the appropriate lensing material for your application.
- Consult factory for lead time.
- All cords are 18/3, 6 ft (1.8 m) or 15 ft (4.6 m) long.
- Bracket supplied by Lusio. Lock nut and other connecting hardware supplied by others. See Installation Instructions for more information.
- The LW-LUSIO-WD-6M is delivered with four mounting straps. Cables supplied by others or see Accessories for Lusio cable kits.





DIMENSIONS: INS (CMS)

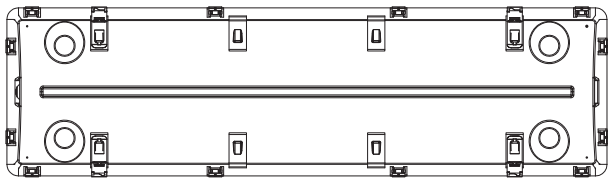

TOP VIEW

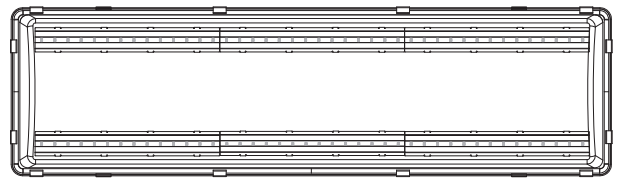

BOTTOM VIEW

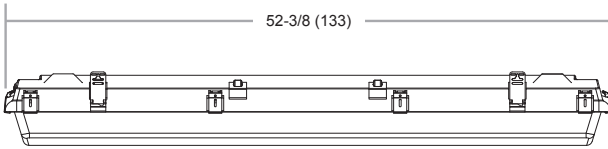

SIDE VIEW

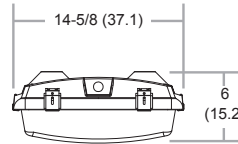

END VIEW

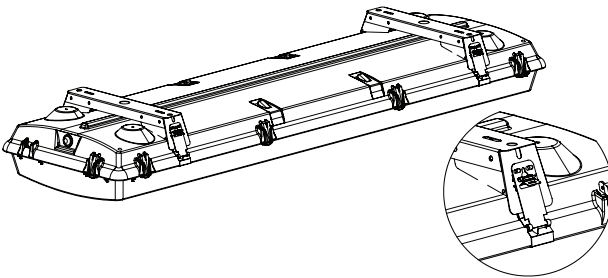

RIGID MOUNTING BRACKET FOR SURFACE OR DUAL PENDANT INSTALLATION  
(SEE INSTALLATION INSTRUCTIONS)

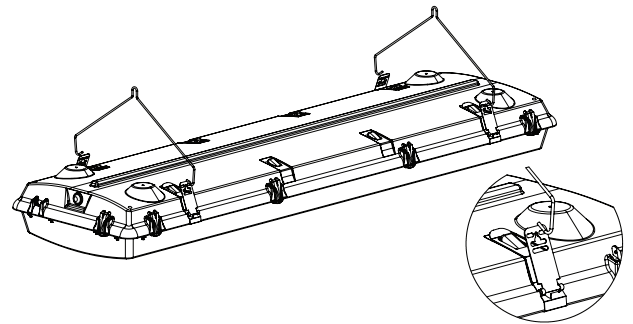

SUSPENSION (SEE INSTALLATION INSTRUCTIONS)